

⊙ BASIC WALL EXAMPLE
1/2" = 1'-0"

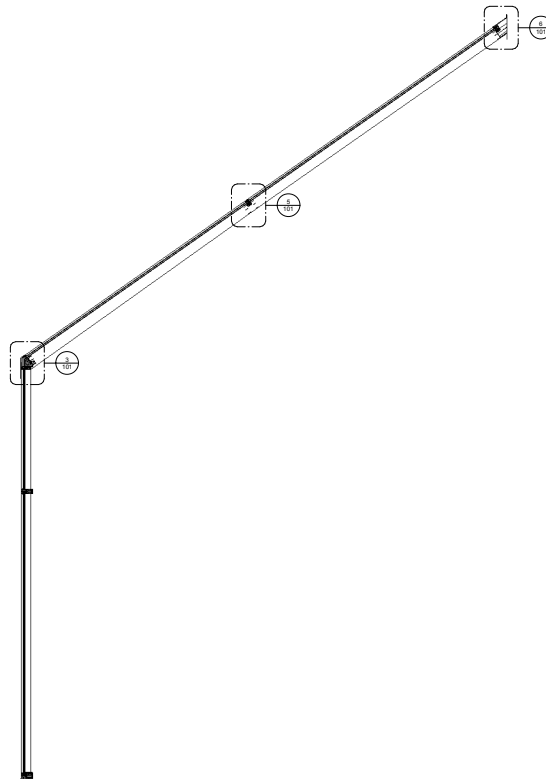

⊙ SECTION
1/2" = 1'-0"

KAWNEER AN ARCONIC COMPANY

555 Guthridge Ct.
Technology Park/Atlanta
Norcross, GA 30092 USA
Tel: +1 770 449 5555

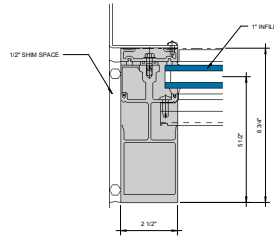

① VERTICAL JAMB
6" = 1'-0"

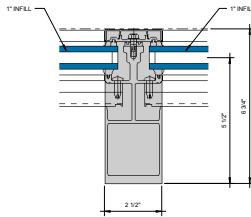

② RAFTER DETAIL
6" = 1'-0"

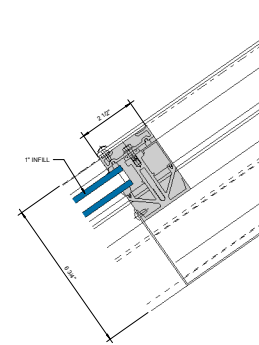

③ HEAD DETAIL
6" = 1'-0"

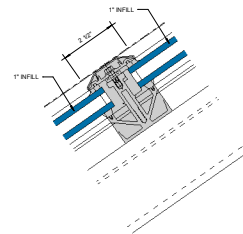

④ PURLIN DETAIL
6" = 1'-0"

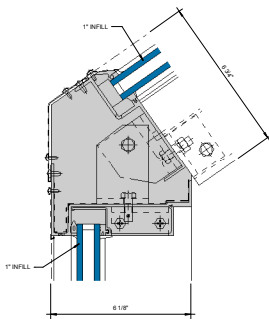

⑤ ADJUSTABLE 35°-60° BAFFLE WITH
6-1/8" GUTTER TRANSITION DETAIL
6" = 1'-0"

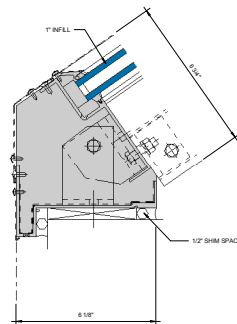

⑥ ADJUSTABLE BAFFLE WITH 6-1/8"
GUTTER SILL DETAIL
6" = 1'-0"

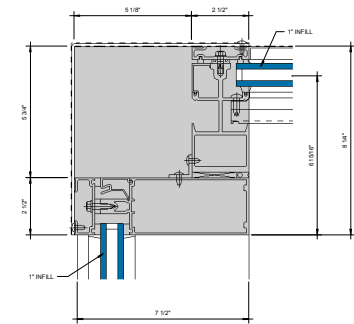
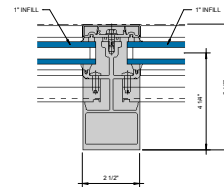
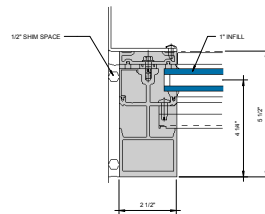
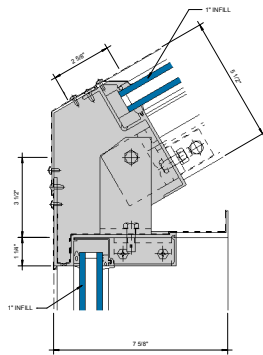
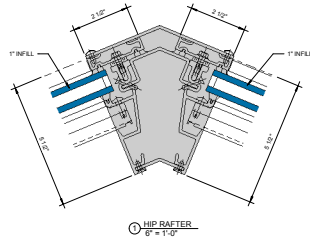

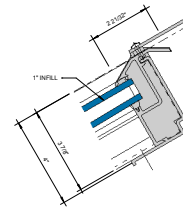

① APPLIED HEAD DETAIL
6" = 1'-0"

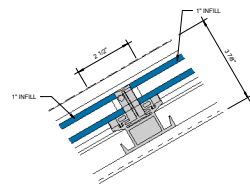

② APPLIED PURLIN DETAIL
6" = 1'-0"

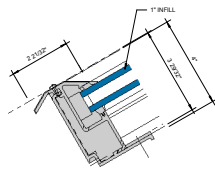

③ APPLIED SILL/TRANSITION DETAIL
6" = 1'-0"

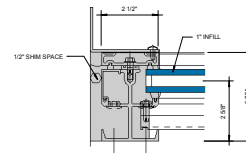

④ VERTICAL JAMB DETAIL
6" = 1'-0"

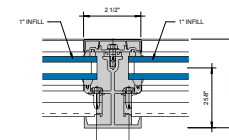

⑤ RAFTER DETAIL
6" = 1'-0"

